

Diverse beslag

* Hele sortimenter udgår. Sælges så længe lager haves

Stillefod til stålrør



Varenr.	Rør	Pris pr. stk.
2501*	25 x 25	

Stillefod til stålrør



Varenr.	Rør	Pris pr. stk.
3001*	30 x 30	

Stillefod til stålrør



Varenr.	Rør	Pris pr. stk.
4001*	40 x 40	

Stillefod ABS plast



Varenr.	Rør	Pris pr. stk.
40.2653	40 x 40	6,00

Stillefod med rustfri flange



Varenr.	Rør	Ø	Pris pr. stk.
15.4003	40 x 40	89	50,00

Rustfrie bøjlegreb



Varenr.	Mål	Skruer	Pris stk.
B96*	96 mm	M4	
B128*	128 mm	M4	
B224*	224 mm	M4	

Lågefastholderbeslag



Varenr.	Pris pr. sæt
7300*	

Måltegning: Lågefastholderbeslag

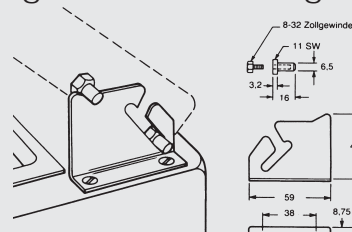

Kantlukkegreb m. sort plast greb

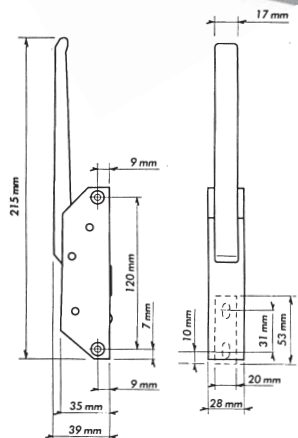

Varenr.	Farve	Pris pr. stk.
5200*	Blankkrom	

Kantlukkegreb m. rustfrit greb

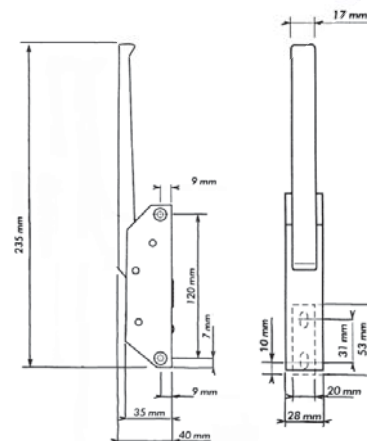

Varenr.	Farve	Pris pr. stk.
5201*	Blankkrom	

Kanthængsel

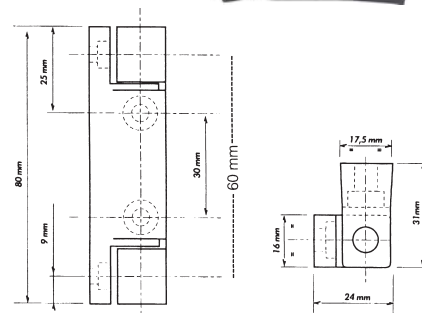

Varenr.	Farve	Pris pr. stk.
5120*	Sort / plast	

* Hele sortimentet udgår, sælges så længe lager haves **Vægskinnesystem**

Hulskinne

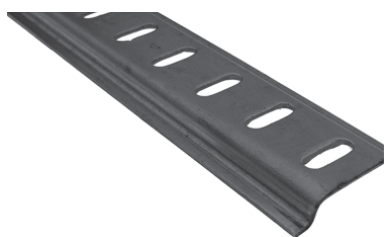

Varenr.	Hul afstand	L	B	Farve	Pris Lgd.
22.0016*	12,5 mm	2 m	2,5 cm	Rustfri	

Hyldebærer



Varenr.	Farve	Bredde	Pris pr. stk.
301010*	Rustfri	16 mm	

Rustfri vægskinne



Varenr.	Længde	Mål cm.	Farve	Enhed	Pris stk.
75.0008*	80 cm	3 x 1,7	Rustfri	stk.	
75.0014*	140 cm	3 x 1,7	Rustfri	stk.	

Klapkonsol

i 300 mm eller 400 mm dybde.

Farver: galvaniseret og hvidlakeret.

3 stillinger 70, 80 og 90°.

Belastning 300 mm = 200 kg,

Belastning 400 mm = 400 kg.

Klapkonsol

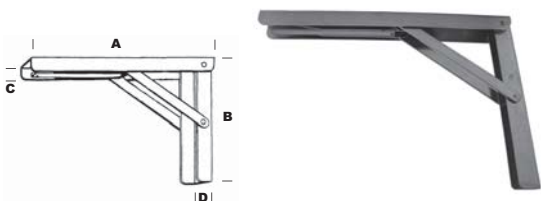

Varenr.	A	B.	C	D	Farve	Enhed	Pris stk.
KLAP3N*	300	200	30	19	Galv.	stk.	
KLAP3H*	300	200	30	19	Hvid	stk.	

Vægskinne + konsol

Vægskinner og konsoller er fremstillet i 2 mm rustfrit stål. Konsollerne kan indsættes og fastgøres på et hvilket som helst sted på vægskinnen uafhængigt af andre monterede konsoller.

Rustfri konsol



Varenr.	Længde	Bredde.	Farve	Enhed	Pris stk.
75.2027*	27 cm.	2 cm	Rustfri	stk.	
75.2037*	37 cm.	2 cm	Rustfri	stk.	
75.2047*	47 cm.	2 cm	Rustfri	stk.	

Ruminddelingsribber

Særdeles velegnet til inddeling af skuffer.

Klar plast der er monteret med dobbeltklæbende tape for hurtig montage.

Mulighed for inddeling for hver 10 mm.

58 mm



35 mm

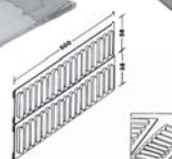
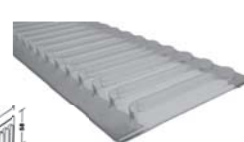

Varenr.	Mål	Enhed	Pris stk.
220101*	2 x 500 x 58 mm	stk.	
220102*	2 x 500 x 35 mm	stk.	

Hjul

◀ Med glidelejer

Ø 50 mm

Zink-kromatiseret gaffel, glidelejer, dobbelt kugledrejekrans og hård gummibane.

1470.50



1475.50



1470.50p



1475.50p



Varenr.	Bremse	Hjul Ø	Bane	Byggehøjde	Belastning	Plade. Str.	Bolt hul	Enhed	Pris pr. stk.
1470.50	nej	50 mm	19 mm	69 mm	50 kg		M10	stk.	
1475.50	Ja	50 mm	19 mm	69 mm	50 kg		M10	stk.	
1470.50P	nej	50 mm	19 mm	69 mm	50 kg	60 x 60	M10	stk.	
1475.50P	ja	50 mm	19 mm	69 mm	50 kg	60 x 60	M10	stk.	

Ø 75 mm

Zink-kromatiseret gaffel, glidelejer, dobbelt kugledrejekrans og hård gummibane..

1470.75



1475.75



1470.75P



1475.75P



Varenr.	Bremse	Hjul Ø	Bane	Byggehøjde	Belastning	Plade. Str.	Bolt hul	Enhed	Pris pr. stk.
1470.75	nej	75 mm	25 mm	100 mm	75 kg		M10	stk.	
1475.75	Ja	75 mm	25 mm	100 mm	75 kg		M10	stk.	
1470.75P	nej	75 mm	25 mm	100 mm	75 kg	60 x 60	M10	stk.	
1475.75P	ja	75 mm	25 mm	100 mm	75 kg	60 x 60	M10	stk.	

Ø100 mm

Zink-kromatiseret gaffel, glidelejer, dobbelt kugledrejekrans og hård gummibane.

1470.100



14751.00



1470.100P



1475.100P



Varenr.	Bremse	Hjul Ø	Bane	Byggehøjde	Belastning	Plade. Str.	Bolt hul	Enhed	Pris pr. stk.
1470.100	nej	100 mm	32 mm	135 mm	80 kg		M10	stk.	
1475.100	Ja	100 mm	32 mm	135 mm	80 kg		M10	stk.	
1470.100P	nej	100 mm	32 mm	135 mm	80 kg	77 x 67	M10	stk.	
1475.100P	ja	100 mm	32 mm	135 mm	80 kg	77 x 67	M10	stk.	

Ø 75-100 mm

Zink-kromatiseret gaffel, dobbelt kugledrejekrans og konuskuglelejer. Hjulbane med hårdt gråt gummi og trådfang.

2470.75



2477.75



2470.100



2477.100



Varenr.	Bremse	Hjul Ø	Bane	Byggehøjde	Belastning	Bolt hul	Enhed	Pris pr. stk.
2470.75	nej	75 mm	25 mm	100 mm	55 kg	M10	stk.	
2477.75	Ja	75 mm	25 mm	100 mm	55 kg	M10	stk.	
2470.100	nej	100 mm	25 mm	135 mm	80 kg	M10	stk.	
2477.100	ja	100 mm	25 mm	135 mm	80 kg	M10	stk.	

Ø 125 - 150 mm

Zink-kromatiseret gaffel, dobbelt kugledrejekrans og konuskuglelejer. Hjulbane med hårdt gråt gummi og trådfang.

24.70125



24.77125



2470125p/150p



2477125p/150p



Varenr.	Bremse	Hjul Ø	Bane	Byggehøjde	Belastning	Plade. Str.	Bolt hul	Enhed	Pris pr. stk.
2470.125	nej	125 mm	32 mm	160 mm	100 kg		M10	stk.	
2477.125	Ja	125 mm	25 mm	160 mm	100 kg		M10	stk.	
2470.125p	nej	125 mm	25 mm	160 mm	100 kg	77 x 67	M10	stk.	
2477.125p	ja	125 mm	25 mm	160 mm	100 kg	77 x 67	M10	stk.	
2470.150p	ja	150 mm	32 mm	185 mm	100 kg	77 x 67	M10	stk.	
2477.150p	nej	150 mm	32 mm	185 mm	100 kg	77 x 67	M10	stk.	

5370.125



5377.125



Ø 100 - 125 mm

Plaststøbt gaffel, glidelejer, dobbelt kugledrejekrans og hård gummibane.



Varenr.	Bremse	Hjul Ø	Bane	Byggehøjde	Belastning	Enhed	Pris pr. stk.
5370.100	nej	100 mm	32 mm	136 mm	100 kg	stk.	
5377.100	Ja	100 mm	32 mm	136 mm	100 kg	stk.	
5370.125	nej	125 mm	32 mm	161 mm	100 kg	stk.	
5377.125	Ja	125 mm	32 mm	161 mm	100 kg	stk.	

Diskben

◀ Slebet rustfri stål

Ben 12



Ben 24



Diskben

- Rustfri diskben
- Stille mulighed op til 10 cm. Se tabel
- Bæreevne: Direkte tryk pr. ben: 150 kg.

 4 stk. el. stykvis

Varenr.	Højde	Enhed	Pris stk.
BEN12	9 - 12 cm	stk.	

Varenr.	Højde	Enhed	Pris stk.
BEN24	14 - 24 cm	stk.	

Ben 35



Ben 74



Ben 92



Varenr.	Højde	Enhed	Pris stk.
BEN35	23 - 32 cm	stk.	

Varenr.	Højde	Enhed	Pris stk.
BEN74	64 - 74 cm	stk.	

Varenr.	Højde	Enhed	Pris stk.
BEN92	84 - 92 cm	stk.	

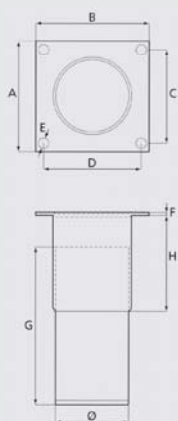

Mål skema:

Varenr.	Højde	A x B	C x D	E mm	H mm	Ø
BEN12	9 - 12 cm	70 x 70	55 x 55	6	62	55
BEN24	14 - 24 cm	100 x 100	66 x 66	8	130	55
BEN35	23 - 32 cm	100 x 100	66 x 66	8	220	55
BEN74	64 - 74 cm	100 x 100	66 x 66	8	640	55
BEN92	84 - 92 cm	100 x 100	66 x 66	8	830	55